

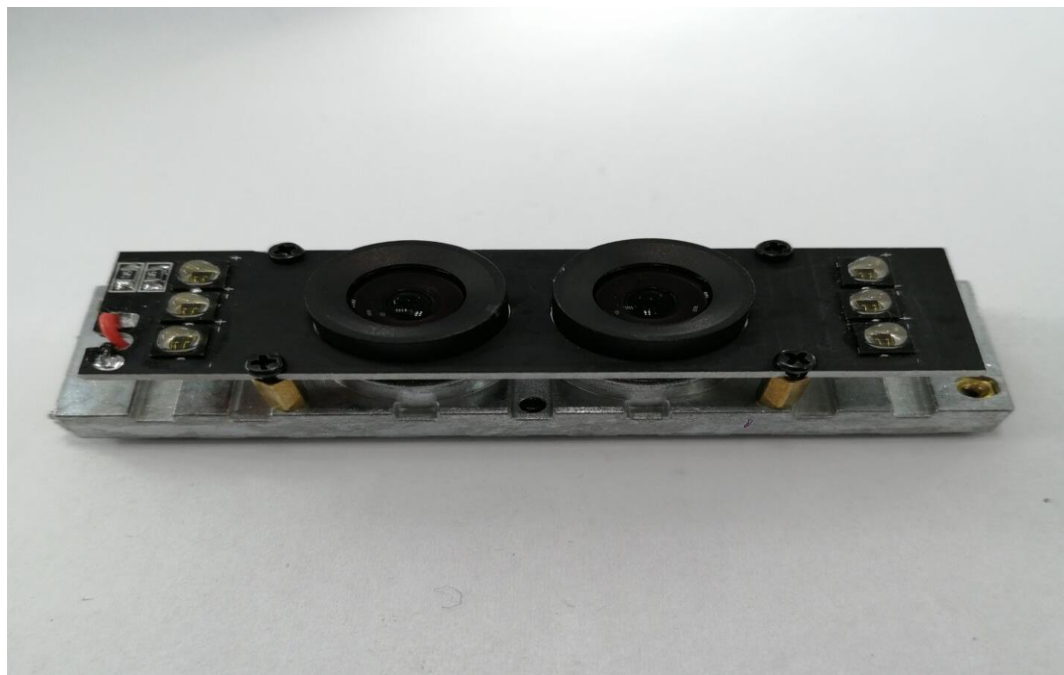

EP17WDLMIR305 USB2.0 RGB/IR Lens Double Camera



1.Product feature(产品特性)	2
2. SPECIFICATIONS(规格书)	3
3. Product (产品尺寸)	4
4. Filter wavelength(滤光片光谱)	5
5.LENS Specification(镜头规格书)	6
6. Cover Proportion (外壳成份)	6
7. Modes of packing (包装方式)	6



USB2.0 RGB/IR Lens Double Camera

1.Product feature(产品特性)

- 1/2.7"+1/3"工业级 200W+130W 高清图像传感器
- RGB:115DB 宽动态, IR: 80DB 适合复杂的光线环境
- 100° (对角) 超广角无畸变高清 500W 像素高清镜头
- 40CM 到无限远清晰成像
- 1500TVL 清晰度
- 0.01Lux (F=1.2) 超低照效果
- 3.0W 功耗
- -30°C~+70°C宽温度范围稳定工作
- 镜头座采用散热片设计, 更快导出热量
- 专业 USB-IF WHQL ROHS CE (4KV/8KV) 认证 (可通过)
- USB2.0 高速传输
- 设备名称 厂家 PID&VID 等描述信息多样化定制
- UVC 架构, 兼容 Windows XP&7&8.1&LINUX&MAC 多种系统
- 长达 1-5 年的质保期&3 万小时无故障寿命
- 表面雅黑喷涂锌镁合金外壳高强度碰撞防护
- 标准 AWM 2725 28AWG/IP 24AWG/2C USB2.0 线
- 平台最低配置: CPU 1.7GHZ 512MB 内存 40GB 硬盘 XP SP2 系统



2. SPECIFICATIONS (规格书)

Common (简介)

Signal	1.3M(IR) B/W	2M(RGB) WDR	REMARKS
Scanning System (扫描方式)	Progressive scan		
Scanning Frequency(H) (扫描频率)	25HZ	25HZ	
Scanning Frequency(V)	N:59.9HZ/P:50HZ	N:59.9HZ/P:50HZ	
Image Sensor (图像感光片)	1/3" CMOS	1/2.7" CMOS	Aptina
Effective Pixels (有效像素)	1280*960	1920*1080	
Pixel size (像素点大小)	3.75umX3.75um	3.0umX3.0um	
Image sensor Data output (数据输出类型)	Raw Data 12bits		
Video output (输出格式)	MPJG / YUY2		
Maximum Frame Rates (分辨率和帧率)	1280x960 at 30fps 1280x720 at 30fps 1024x768 at 30fps 800x600 at 30fps 640x480 at 30fps 352x288 at 30fps 320x240 at 30fps 160x120 at 30fps	1920x1080 at 30fps /1280x1024 at 30fps /1280x768 at 30fps /1024x720 at 30fps /960x540 at 30fps /800x600 at 30fps /640x480 at 30fps/352*288 at 30fps/320*240 at 30fps/160*120 at 30fps	MJPG
Maximum Frame Rates (分辨率和帧率)	1280x960 at 9fps 1280x720 at 9fps 1024x768 at 10fps 800x600 at 20fps 640x480 at 30fps352x288 at 30fps 320x240 at 30fps 160x120 at 30fps	1920x1080 at 5fps /1280x1024 at 10fps /1280x768 at 10fps /1024x720 at 10fps /960x540 at 15fps 800x600 at 20fps /640x480 at 30fps/352*288 at 30fps/320*240 at 30fps/160*120 at 30fps	YUY2
SNR max (信噪比)	≥50dB	≥50dB	
Dynamic range (动态范围)	≥80dB	≥115dB	
Min. Illumination (最低照度)	≥0.01LUX at F1.2	≥0.01LUX at F1.2	NO LED
Digital interface (连接接口)	1*2-pin 1.25mm//2*GH5* 1.25mm USB2.0		
Transfer rates (接口速度)	480MB/S		
Power requirements (电源)	5V±0.5		
Power Consumption (功率)	NO LED	Max 1.8W	
	IR-LED	Max 3.0W	
LED IR-850(红外灯光强)	≤90° 1.0m	NO	LED
Lens Mount (可搭配镜头类型)	M12(f=3.5MM)		
Lens view (默认镜头)	M12/ H=85° V= 53°		LENS
Dimensions(PCBA) mm尺寸	70mm*17mm*18mm		长*高*深
OS (支持系统)	Windows XP /vista/seven/8.1/Mac linux2.6.2(include UVC)		
General Purpose辅助接口定义	5V+	LED+	250mA max
	GND	LED-	
USB CONN接口定义	1	5V	USB POWER-500mA max
	2	DM	D+
	3	DP	D-
	4	GND	DGND
	5	COVER	SHIELD

Attention: 注意:

- Brightness Sharpness Contrast Hue Saturation Gamma Automatic white balance Back light Exposure can be controlled ; 亮度; 锐度; 对比度; 色温; 饱和度; 伽马; 白平衡; 曝光可以控制;

固化参数	亮度	对比度	色调	饱和度	清晰度	伽玛	白平衡	逆光对比	增益	曝光	镜像
最小值	-64	0	-40	0	0	72	2800	0	0	-13	0
最大值	64	64	40	128	6	500	6500	2	100	-1	3

2. professional SDK support for second develop. 专业的 SDK 支持二次开发

3. VID&PID(公司&产品识别码): IR:1871& 1501 / ASPIRE***** RGB:1871& 1130 / ASPIRE*****

3.Product Dimension (产品尺寸)

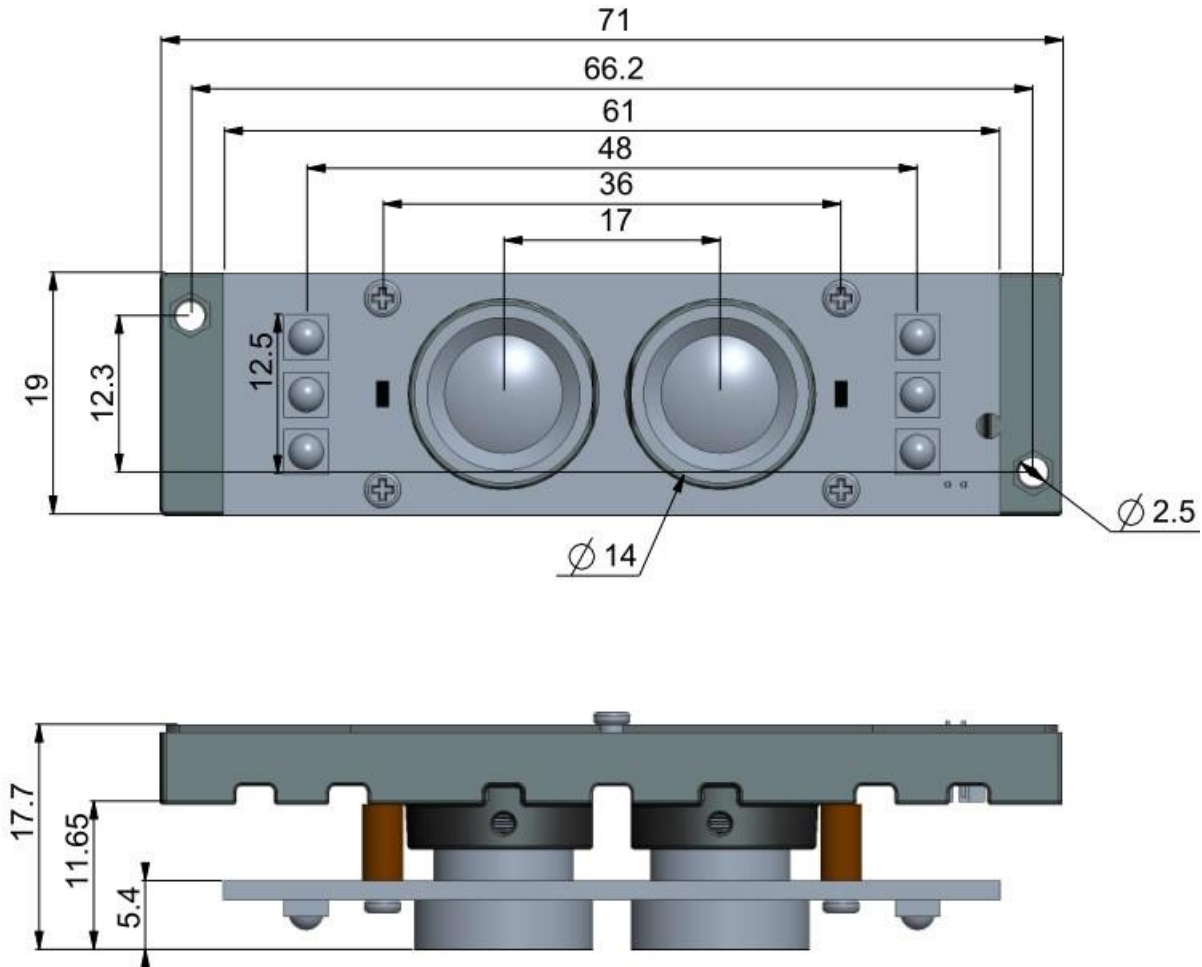



B.USB2.0 data line specification 数据线规格书

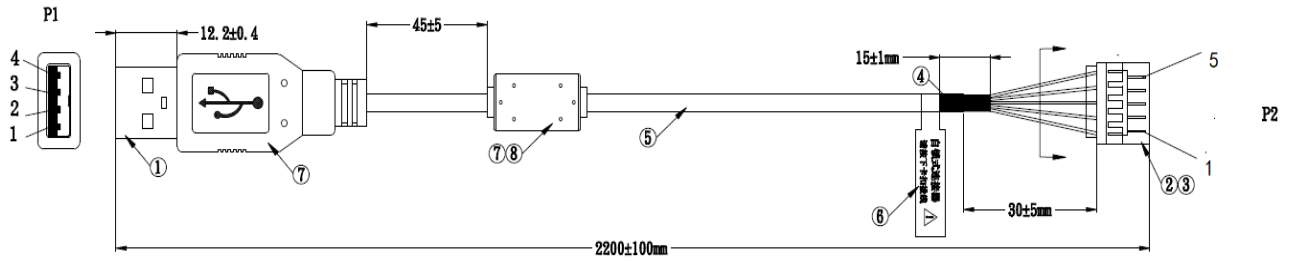

接点图

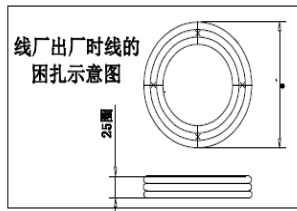
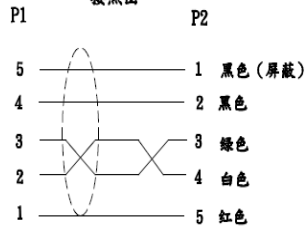

中英文标贴示意图:

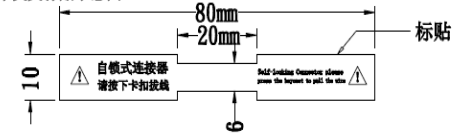

材质: 不干胶 字体颜色: 黑色
 标贴内容: 自锁式连接器 Self-locking Connector please
 标贴: 自锁式连接器 请按下卡扣拔线 press the keypost to pull the wire
 ⚠: 黑色边框黄色警告标示

备注:

1. 成品须做100%电性测试, 不能有断路, 短路, 错位, 间歇接触不良等状况
2. 导通阻抗 3Ω ; 绝缘 $5M\Omega$; DC300/0.01s;
3. 所有物料需符合普通环保要求

4.Filter wavelength (滤光片光谱)

C1.RGB Filter wavelength (彩色滤光片光谱)

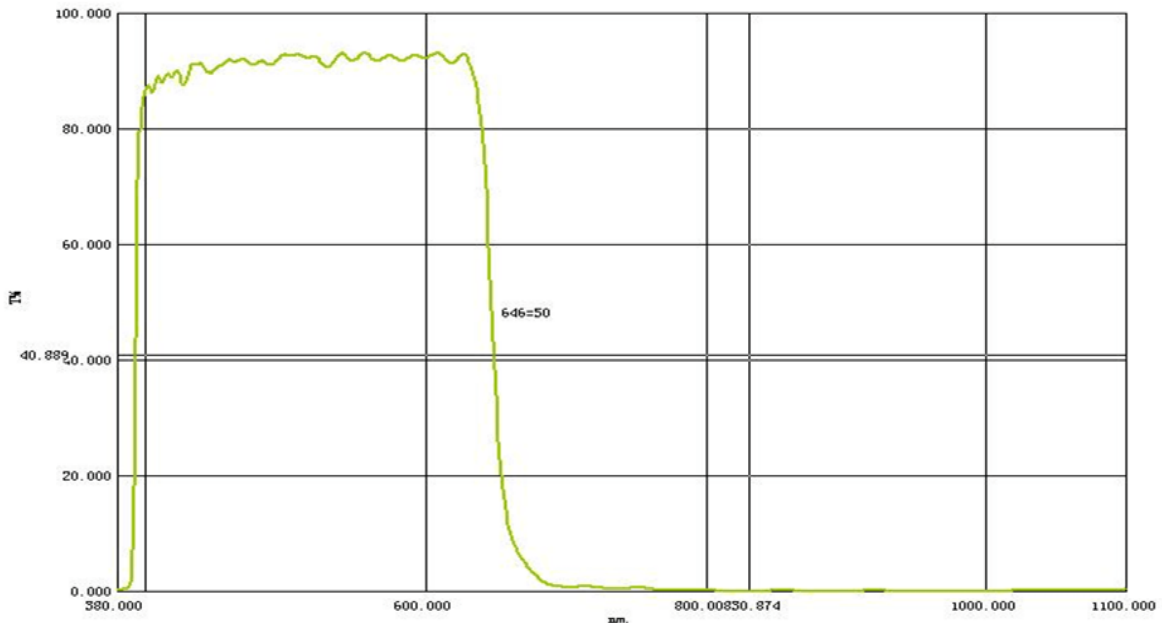

C2.IR Filter Wavelength(黑白滤光片光谱)

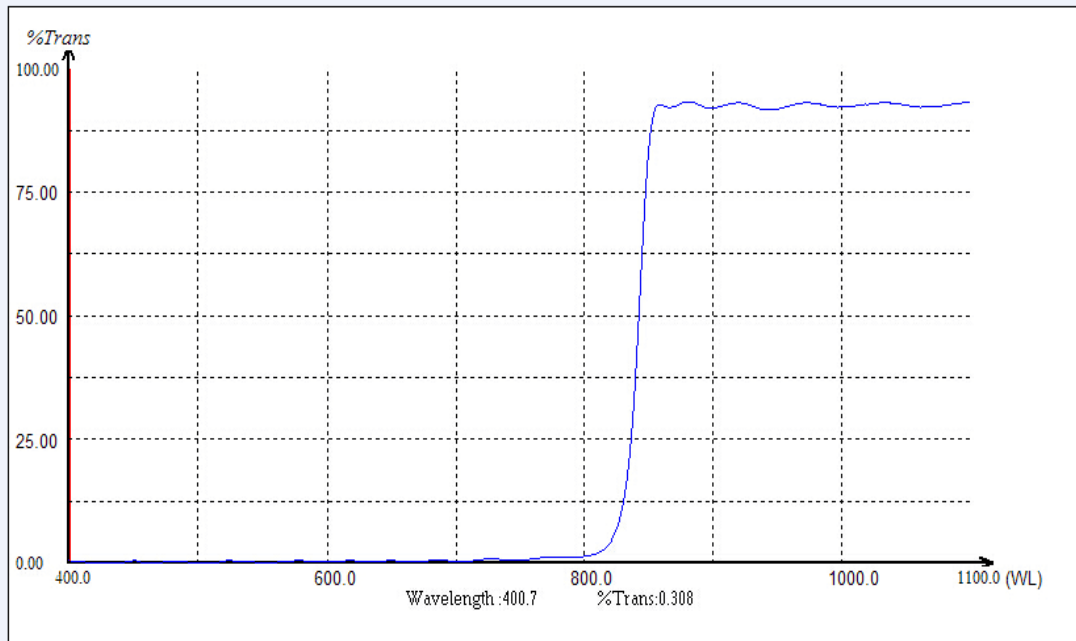

5.LENS Specification(镜头规格书)

PRODUCT NAME : PO/2018

1. SPECIFICATION:

1.RESOLUTION	5M
2.MAX IMAGE CIRCLE	φ6.6 mm
3.FOCAL LENGTH (EFL)	f= 3.18±5% mm
4.F/NO (INFINITE)	F/NO= 2.0±5%
5.BACK FOCAL LENGTH	BFL= 3.80±0.2mm
6.FLANGE BACK LENGTH	FB= 2.85±0.2mm
7.Thread Size	M12*P0.5
8.Element	ZG2P

NOTE

SPECIFICATION	
Sensor	1/3" OV4689 1/3" AR0130 1/2.7" AR0230
Vertical	51.2°x1.543mm 59.0°x1.822mm 54°x1.638mm
Horizontal	80.5°x2.723mm 73.8°x2.416mm 84°x2.90mm
Diagonal	89.0°x3.162mm 86.5°x3.027mm 91.8°x3.30mm
DISTORTION	<-0.95% <-0.95% <-0.95%
Relative Ill.	<40.2% <43.8% <40.2%
CRA	<20.1° <19.0° <20.1°

2. OPTICAL LAYOUT:

REV	DESCRIPTION	DATE	NAME	NAME	PO/2018	SCALE	DRAWN
①	新規作成	2018.3.20		VIEW	REV 00		
②						DATE	CHECKED
③					ASPIRE .CO	BORDER	APPROVED
④							

PRODUCT NAME : PO/2017

1. SPECIFICATION:

1.RESOLUTION	5M
2.MAX IMAGE CIRCLE	φ6.6 mm
3.FOCAL LENGTH (EFL)	f= 3.18±5% mm
4.F/NO (INFINITE)	F/NO= 2.0±5%
5.BACK FOCAL LENGTH	BFL= 3.80±0.2mm
6.FLANGE BACK LENGTH	FB= 2.85±0.2mm
7.Thread Size	M12*P0.5
8.Element	ZG2P+IR
9.IR FILTER SPEC.(Built-in,Others available)	Tavg>=88% ● 440-620 nm T=50% ● 648±10 nm Tavg<=3% ● 680-780 nm T=50% ● 820±10 nm Tavg>=88% ● 840-860 nm T<3% ● 880±10 nm ● 920-1100 nm

NOTE

SPECIFICATION	
Sensor	1/3" OV4689 1/3" AR0130 1/2.7" AR0230
Vertical	51.2°x1.543mm 59.0°x1.822mm 54°x1.638mm
Horizontal	80.5°x2.723mm 73.8°x2.416mm 84°x2.90mm
Diagonal	89.0°x3.162mm 86.5°x3.027mm 91.8°x3.30mm
DISTORTION	<-0.95% <-0.95% <-0.95%
Relative Ill.	<40.2% <43.8% <40.2%
CRA	<20.1° <19.0° <20.1°

2. OPTICAL LAYOUT:

REV	DESCRIPTION	DATE	NAME	NAME	PO/2017	SCALE	DRAWN
①	新規作成	2018.3.20		VIEW	REV 00		
②						DATE	CHECKED
③					ASPIRE .CO	BORDER	APPROVED
④							

6.Cover proportion(mm) (外壳成份)

NO.	component	Proportion	NOTE
1	ZN	96.2000%	
2	CU	0.0160%	
3	Aluminum	3.7000%	
4	Fe	0.0030%	
5	Pb	0.0025%	



6	Sn	0.0004%	
7	Mg	0.0030%	

7. Modes of packing (包装方式)

